

安装说明
TR-Frost Spirit 140 系列

配件清单

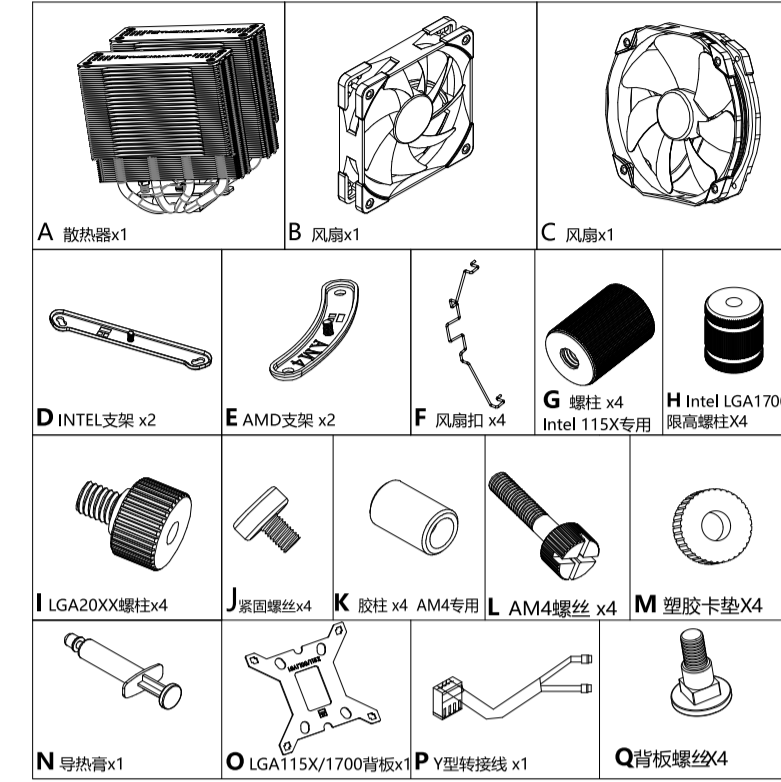

AMD AM4

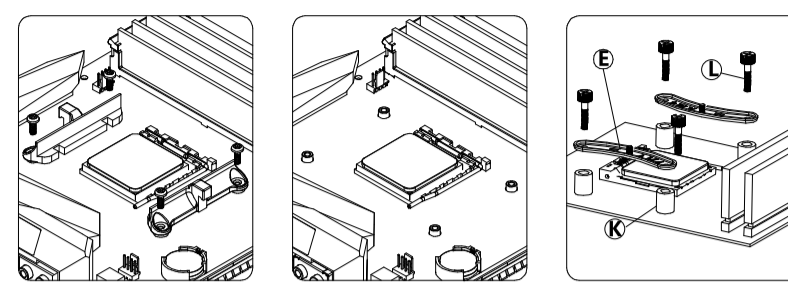

移除 AMD 原装塑胶支架，保留背板；使用AM4 胶柱锁紧到主板原配底板

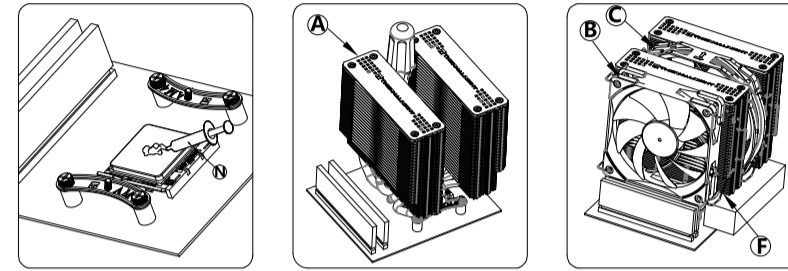

涂好导热膏，然后用螺丝刀锁好主体，再用风扇线扣固定风扇

INTEL LGA115X

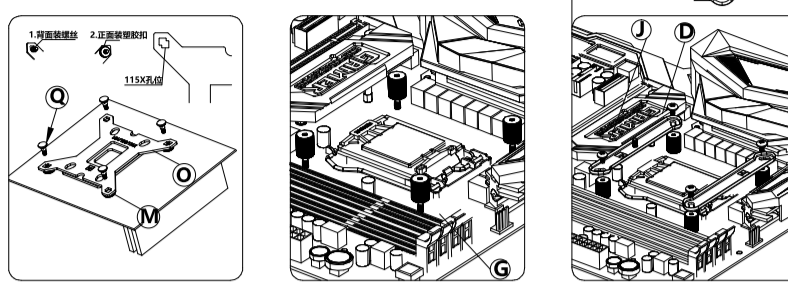

先将背板按图示装入115X孔位再用O形塑胶垫卡住，再将背板放置在主板背面，然后扭紧螺柱，再用螺丝固定住支架（支架孔位对准115X）。

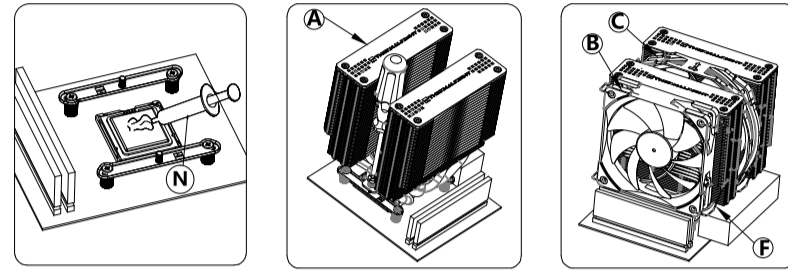

涂好导热膏，然后用螺丝刀锁好主体，再用风扇线扣固定风扇

INTEL LGA20XX

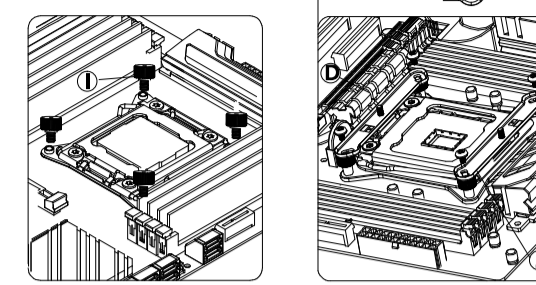

将 LGA20XX 螺柱拧到主板，然后放置支架，再用螺帽固定住INTEL 支架。

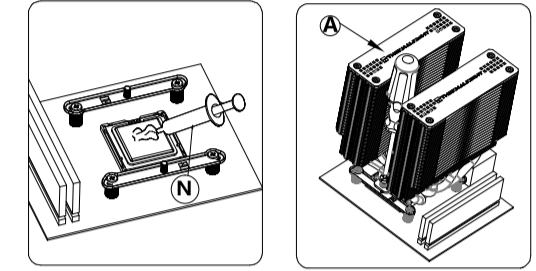

涂好导热膏，然后用螺丝刀锁好主体，再用风扇线扣固定风扇

LGA1700

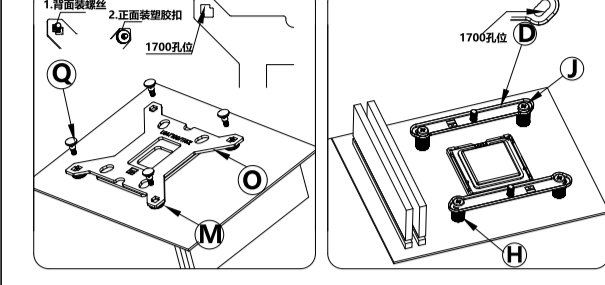

先将背板按图示装入1700孔位再用O形塑胶垫卡住，再将背板放置在主板背面，然后扭紧螺柱，再用螺丝固定住支架（支架孔位对准1700）。

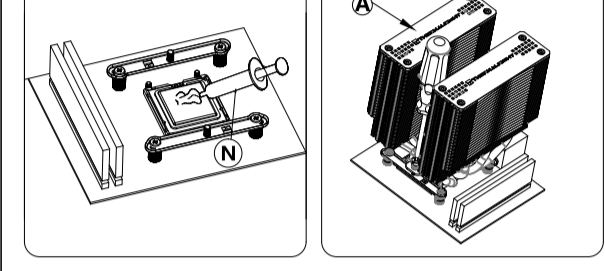

涂好导热膏，然后用螺丝刀锁好主体，再用风扇线扣固定风扇

风扇接线

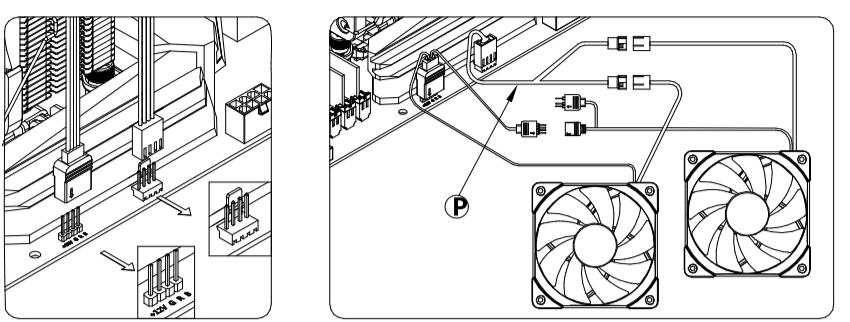

将风扇4针头插入主板 CPU FAN 插座，使用Y型转接线，如果风扇支持RGB，将风扇4针头光线插入主板 12V 4P RGB插座，风扇为串联

INSTALLATION GUIDE
TR-Frost Spirit 140 Series

Accessories list

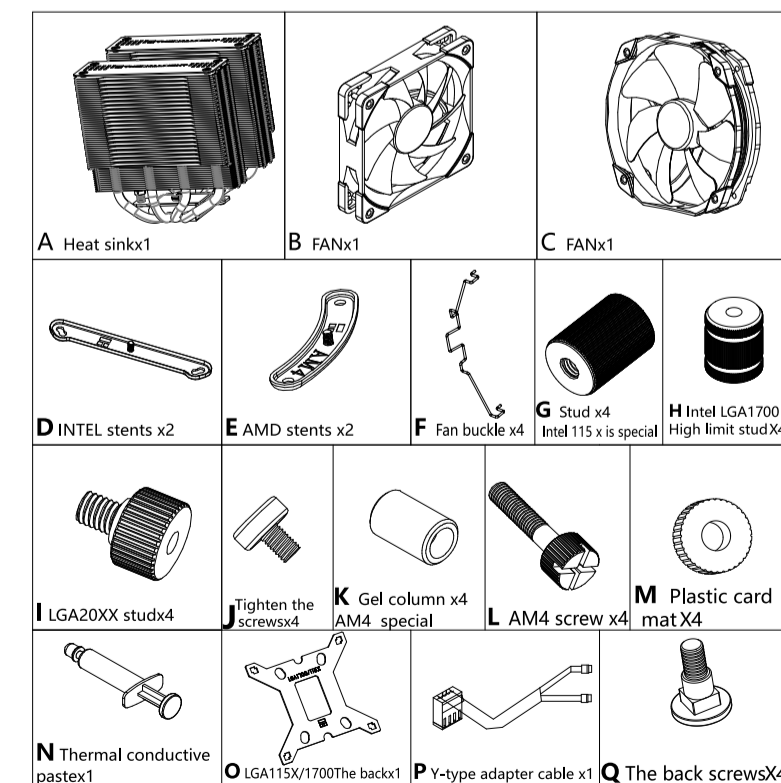

AMD AM4

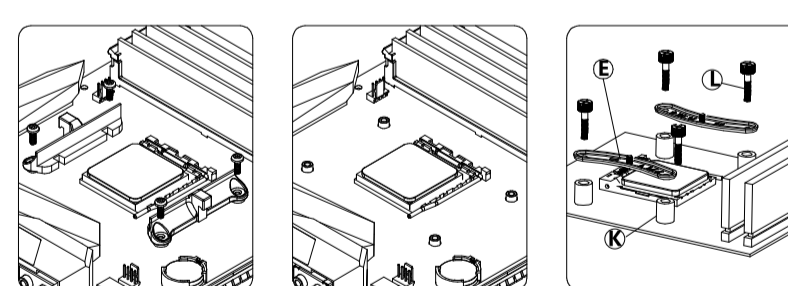

Remove AMD's original plastic bracket and retain the backplane; Use AM4 glue column to lock the original mainboard base plate

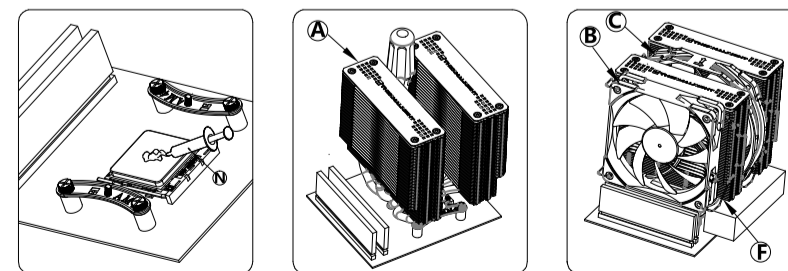

Apply thermal paste, lock the main body with a screwdriver, and secure the fan with a cable tie

INTEL LGA115X

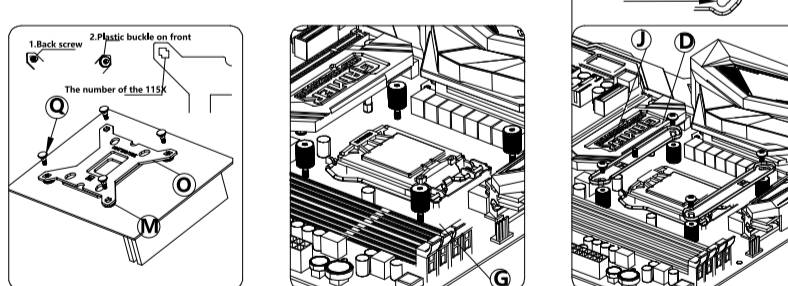

Install the backplane into the 115X hole as shown in the picture and then jam it with the O-shaped plastic pad. Then place the backplane on the back of the motherboard, tighten the studs, and secure the support with screws (the support hole is aligned with 115X).

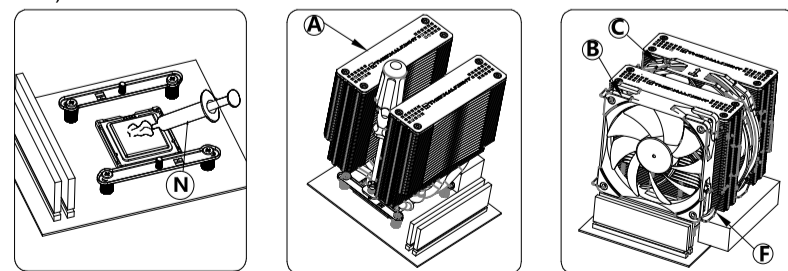

Apply thermal paste, lock the main body with a screwdriver, and secure the fan with a cable tie

INTEL LGA20XX

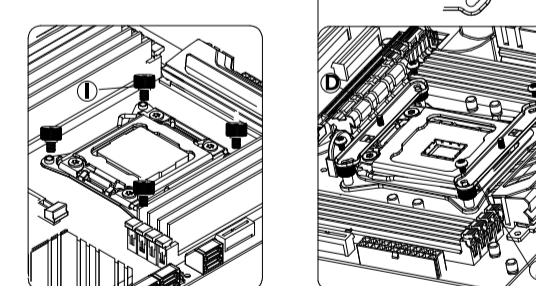

Screw the LGA20XX studs onto the motherboard, place the bracket, and secure the INTEL bracket with nuts.

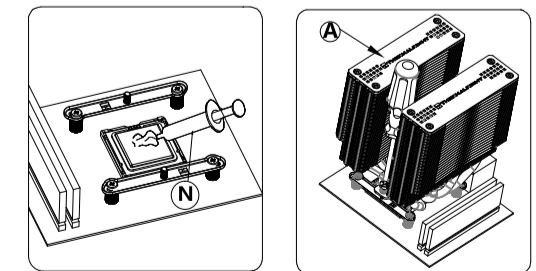

Apply thermal paste, lock the main body with a screwdriver, and secure the fan with a cable tie

LGA1700

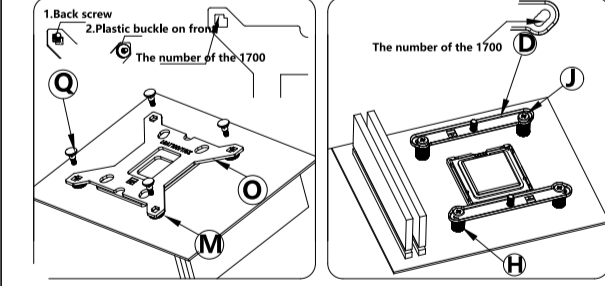

Install the backplane into 1700 holes as shown in the picture and then jam it with o-shaped plastic pad. Then place the backplane on the back of the motherboard, tighten the studs, and fix the support with screws (the support hole is aligned with 1700).

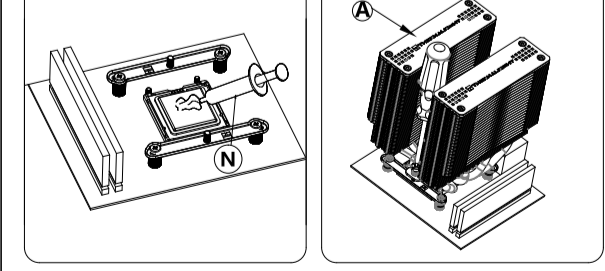

Apply thermal paste, lock the main body with a screwdriver, and secure the fan with a cable tie

Fan wiring

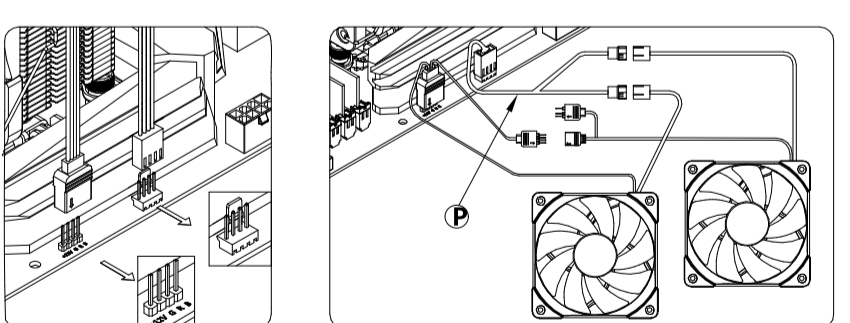

Insert the FAN 4-pin into the CPU FAN socket on the motherboard and use the Y-type adapter cable. If the FAN supports RGB,

Insert the fan 4-pin light line into the 12V 4P RGB socket on the mainboard, and the fan is in series